

ZENSOL

WWW.ZENSOL.COM

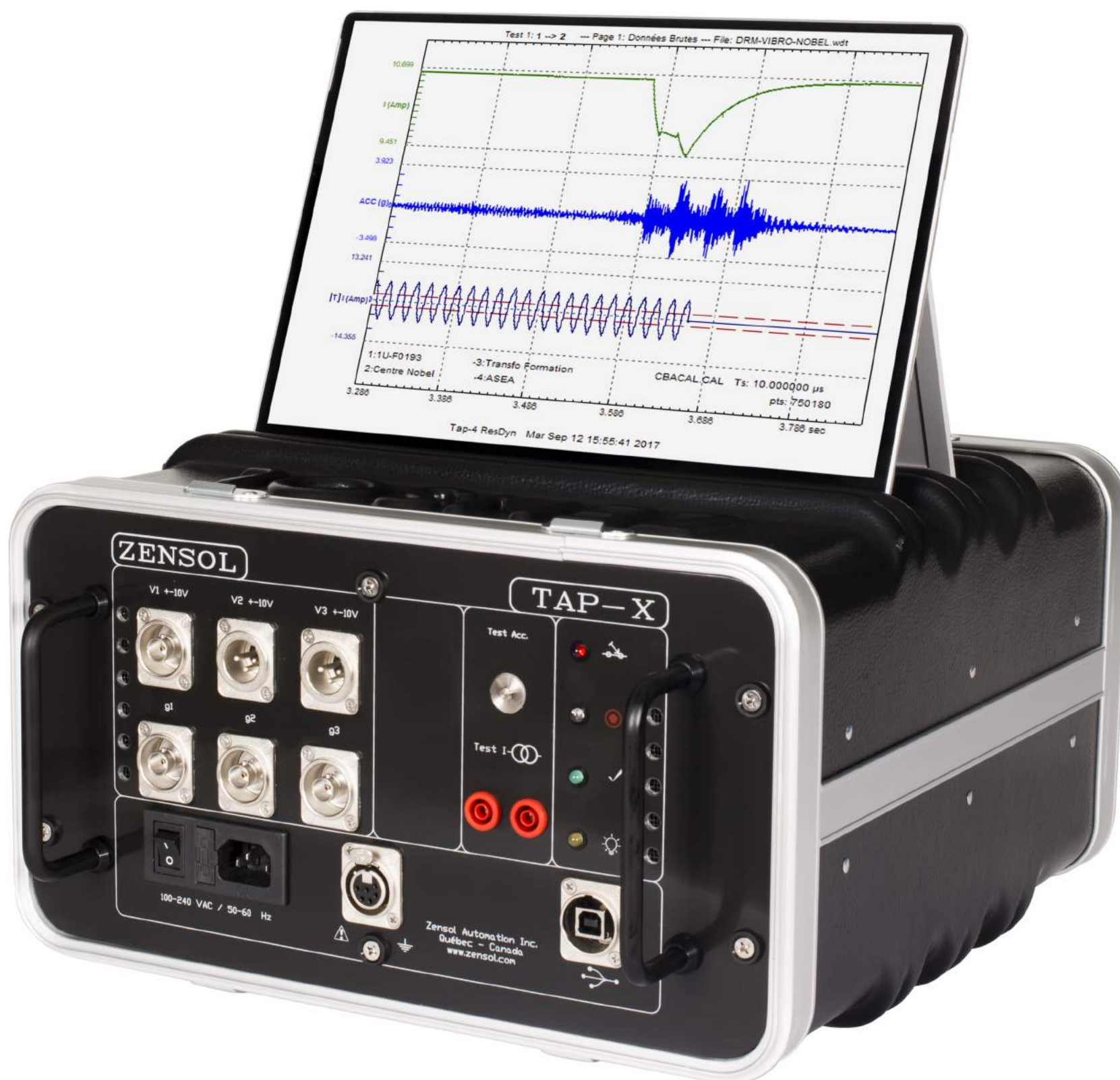

OLTC DIAGNOSIS
TAP-4, TAP-4-PLUS, OTM-X

SHARING KNOWLEDGE

To learn more about OLTC diagnosis, visit our web site, you will find many articles

www.zensol.com/en/sharing-knowledge

INDEX

Existing methods of testing OLTCs	4
Vibro-acoustic method	5
What is the TAP-4?	6
What is the TAP-4-PLUS?	7
What is the OTM-X?	8
Characteristics comparison: TAP-4, TAP-4-PLUS, OTM-X	9
TAP-4-PLUS versus TAP-4	10
Why the vibro-acoustic method?	11
Dynamic resistance DRM	12
Transducers	14
Cables	16
Cases and bags	17
Processing software OpenZen-TAP	18
Testing services/Analysis services	19

WHY VIBRO-ACOUSTIC METHOD?

RECOGNIZED BY CIGREE AND IEEE

The vibro-acoustic method was developed and tested in the field by Hydro-Québec for over 20 years. Its diagnostic potential has been recognized in two transformer maintenance guides: **IEEE.PC57.143** and **Cigré A2.34**.

THE TAP-4

The TAP-4, designed for transformers testing, was created in 2008. It became the first portable instrument using the vibro-acoustic method to perform tests on On-Line Tap Changers (OLTC).

Since then, Zensol has also introduced to the market other instruments for OLTC testing: the OTM-X and the TAP-4-PLUS.

LIKE A STETHOSCOPE

Just like a stethoscope, our units listen to the heartbeat of your OLTC without opening it. They can create a complete overview of the internal state and can detect a wide variety of mechanical and electrical malfunctions.

ABLE TO TEST ALL OLTCs

Our units are able to test all OLTC types such as: resistor, reactor or vacuum, of any brands (Maschinenfabrik Reinhausen (MR), ABB, Federal Pioneer, Ferranti, etc.).

RUGGED AND RELIABLE

Their portability and resistance to impacts and extreme climate conditions make them precious and highly appreciated instruments.

The table on page 4 summarizes the advantages of each testing method.

WHAT IS THE TAP-4?

The TAP-4 is the first portable instrument using the vibro-acoustic method to perform tests on On-Line Tap Changers (OLTC) for transformers. With the TAP-4, you can do tests both online and offline. Simple to use, the OpenZen-TAP software drives the instrument, records and analyzes OLTC events.



WHAT IS THE TAP-4-PLUS?

The TAP-4-PLUS is the newest instrument by Zensol for OLTC testing. It has 2 more analog inputs than the TAP-4. The TAP-4-PLUS with TAP-DRM accessory can perform dynamic resistance and vibration recordings at the same time. Doing so will allow you to easily understand the vibration impacts.

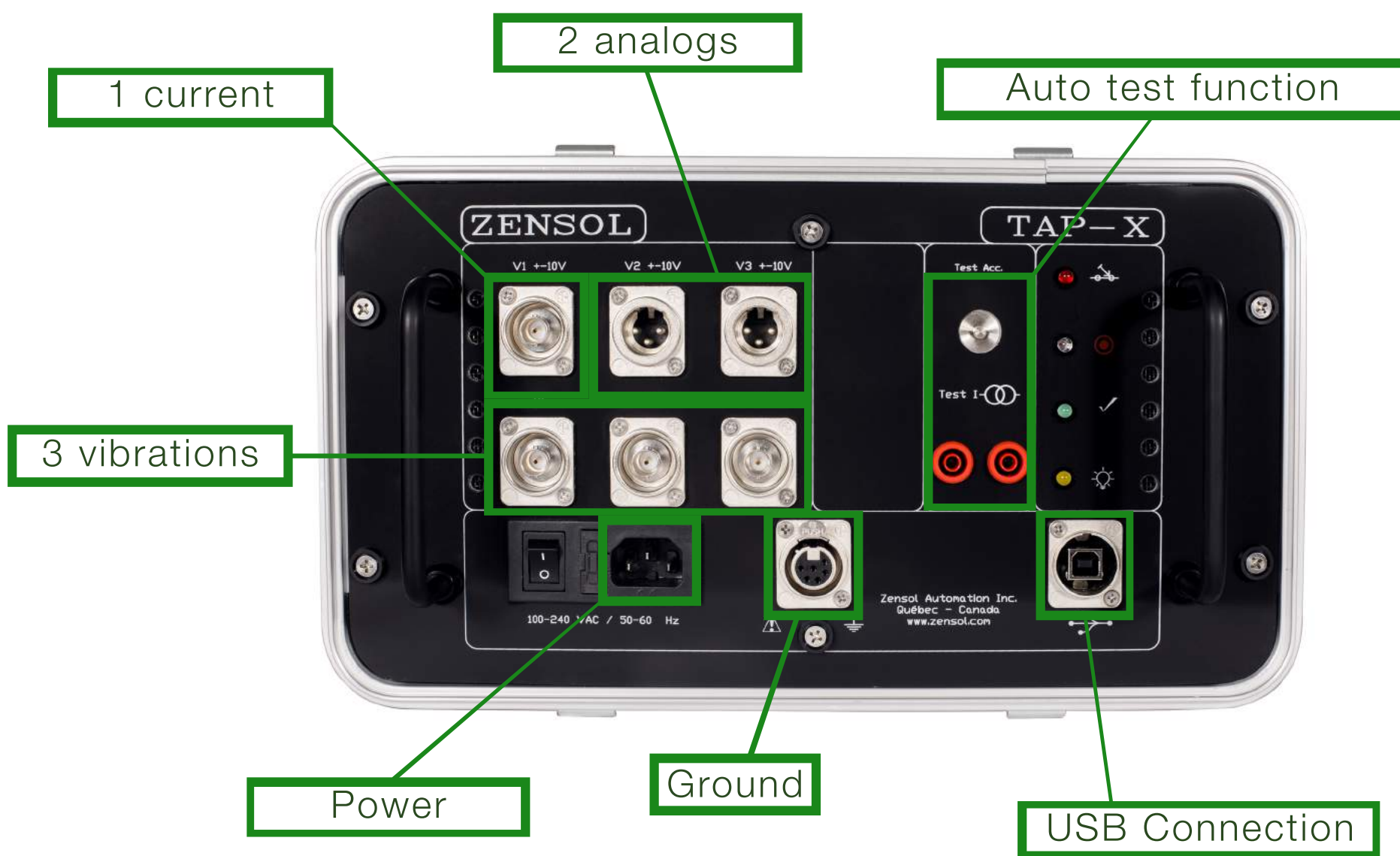

WHAT IS THE OTM-X?

STANDALONE OLTC EVENT RECORDER

The OTM-X is the only standalone recorder on the market using the vibroacoustic method and the motor current test. The OTM-X records every tap change operation, whether the transformer is ONLINE or OFFLINE.

You can access your data wherever you are at any time through the OTM-X's ethernet connection.

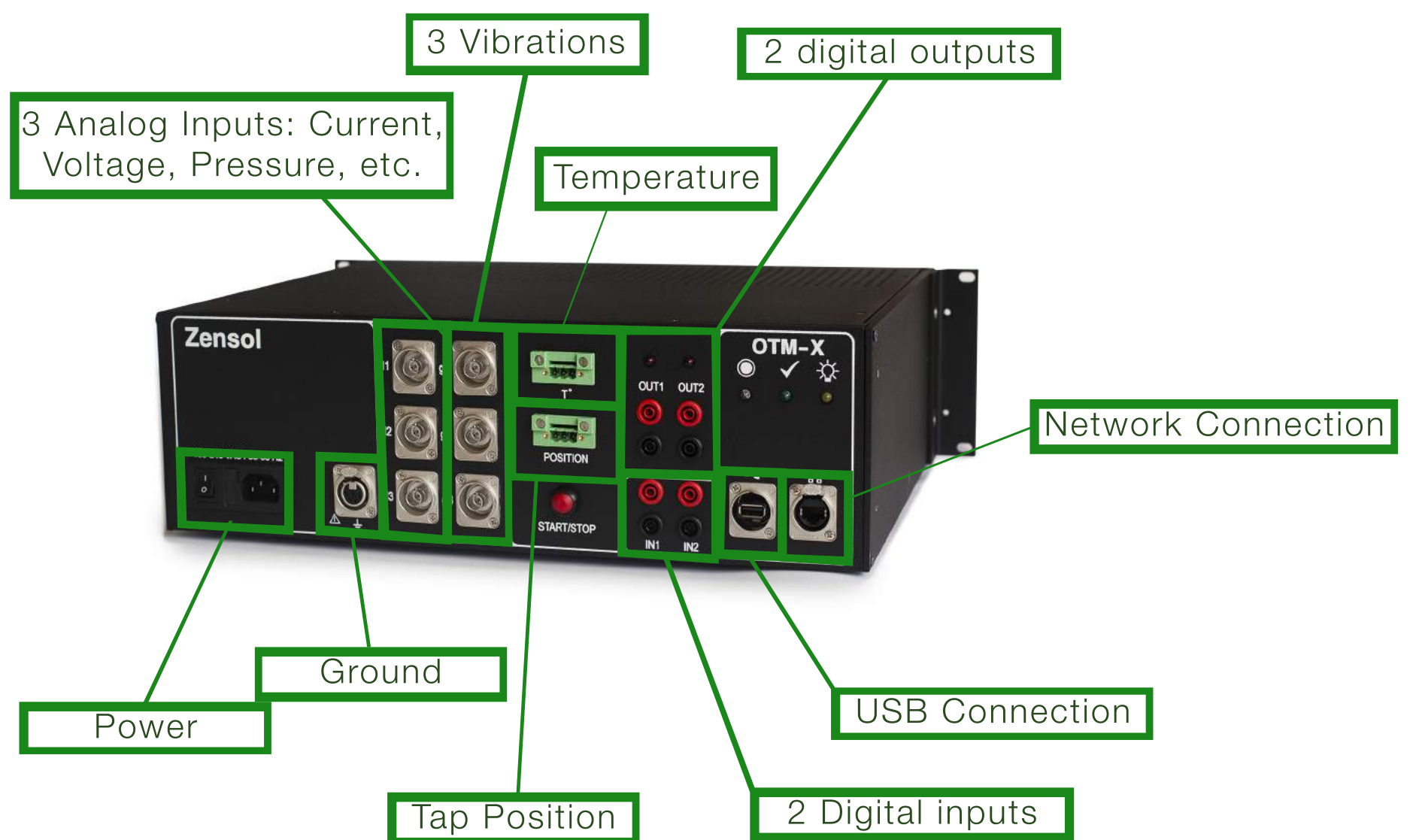

CHARACTERISTICS COMPARISON: TAP-4, TAP-4-PLUS, OTM-X

	TAP-4	TAP-4-PLUS	OTM-X
Sampling frequency	100 kHz	100 kHz	100 kHz and less
Sampling time microseconds (μ s)	10 μ s	10 μ s	10 μ s and more
Analog inputs (-10V to +10V)	1	3	5
Accelerometer inputs	3	3	3
External Trigger	YES	YES	YES
Dynamic Resistance capability (DRM)	NO	YES	YES
Standalone	NO	NO	YES

The analysis of vibration signals requires a sampling frequency of at least 100kHz. A lower sampling frequency is unacceptable because the recordings have a poor quality.

TAP-4-PLUS

IS A TAP-4 WITH 2 ADDITIONAL
ANALOG INPUTS



We added 2 analog inputs to give the capacity to the TAP-4 to do DRM (Dynamic resistance measurement) test. By combining DRM and Vibro we get the best of each method.

VIBRO-ACOUSTIC WHY?



TAP-4-PLUS



OTM-X



TAP-4

Accelerometer
(10g and 50g)

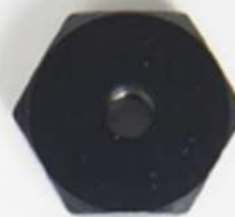

Mounting base

- Non-intrusive
- Identify problems that classical tests cannot detect
- On-line/Off-line
- Adaptable to all OLTC types

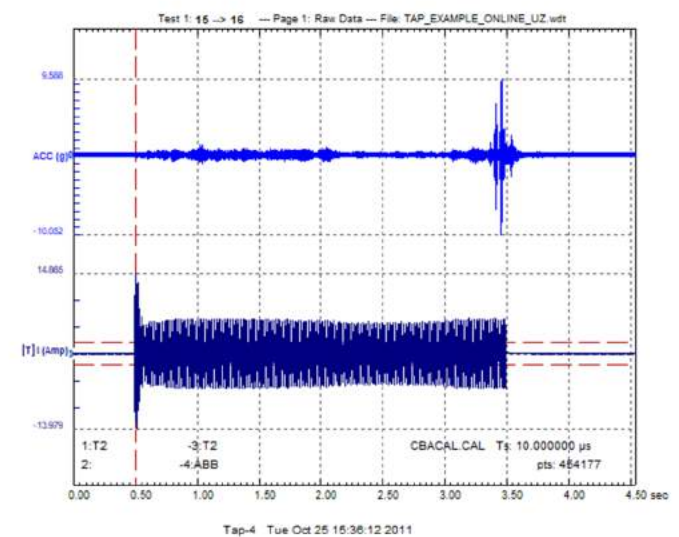

DYNAMIC RESISTANCE DRM



This accessory used with TAP-4-PLUS allows you to do DRM testing.
Easy correlation between vibro-acoustic, DRM and motor current

MR OLTC



ABB OLTC



DYNAMIC RESISTANCE DRM WHY?

Malfunctions detected by DRM

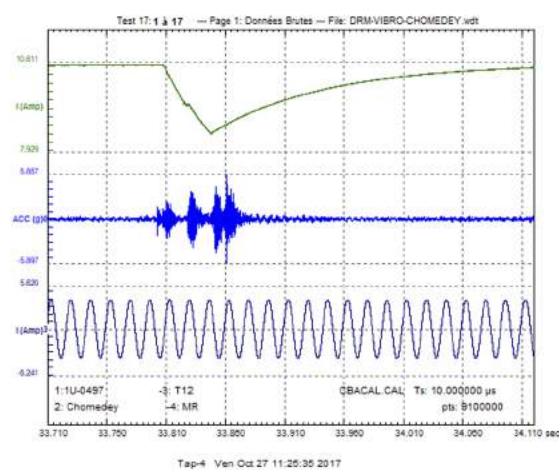
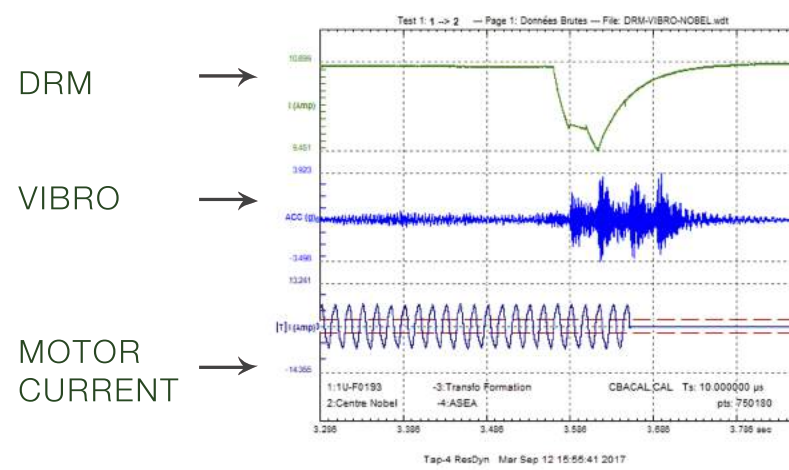
According to CIGRE A2.34, the dynamic resistance measurements or DRM (OFFLINE test) offers diagnostics for several diverter or selector switch malfunctions such as: contact problems, broken springs, broken transition resistors, poor contact pressure, inadequate transition time, momentary open circuit, and synchronism motion issues.

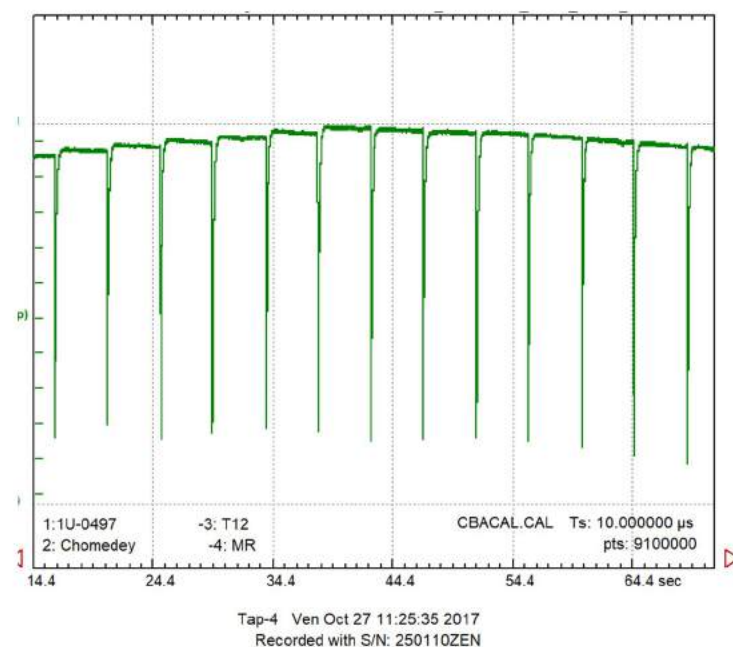

Zensol's DRM principle

Tap windings are powered with a DC voltage source. The current fluctuations are recorded during the switching process. The schematic below shows the principle of the dynamic resistance measurement.

Typical switching sequence

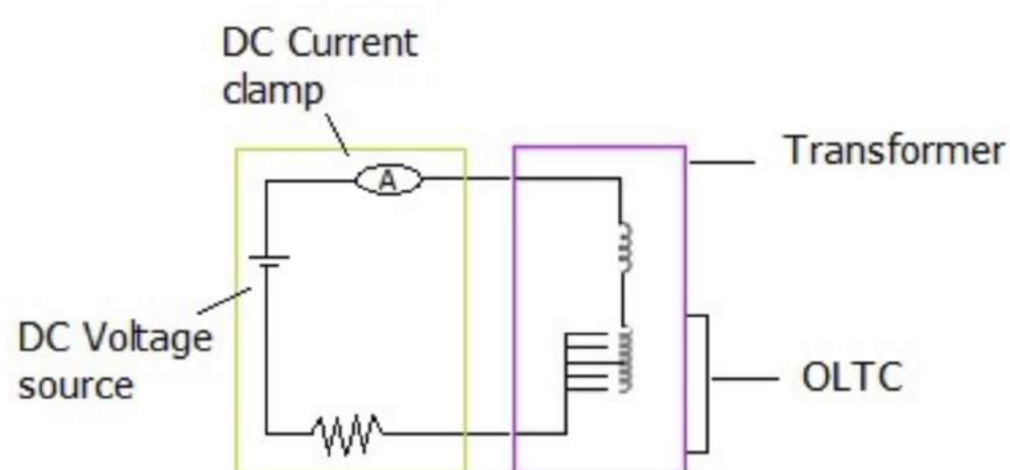
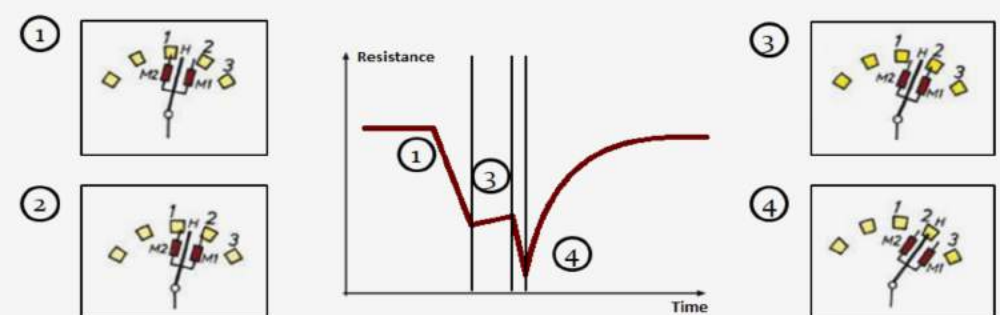

- Instruments equivalent scheme
- Transformer equivalent scheme

Test set up



CURRENT TRANSDUCER AC or AC/DC CLAMP



AC CLAMP



AC/DC CLAMP

Starts and stops a recording during a tap transition for AC or DC motor drive

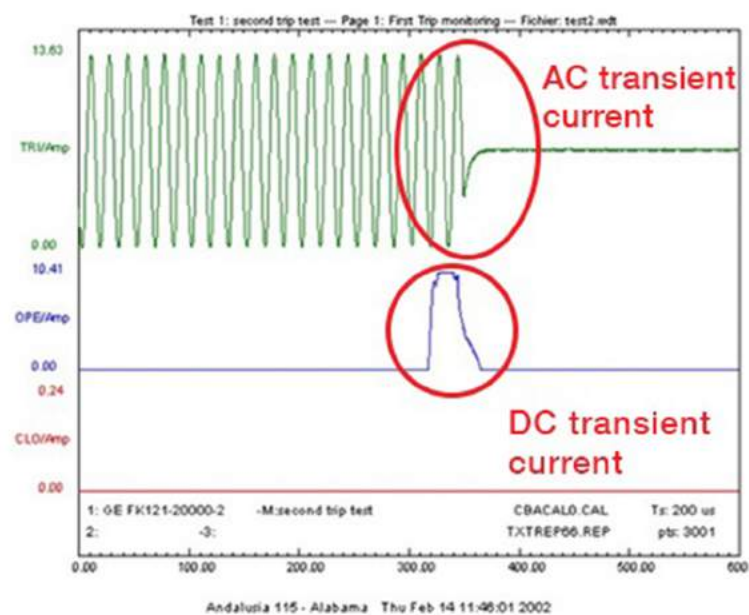
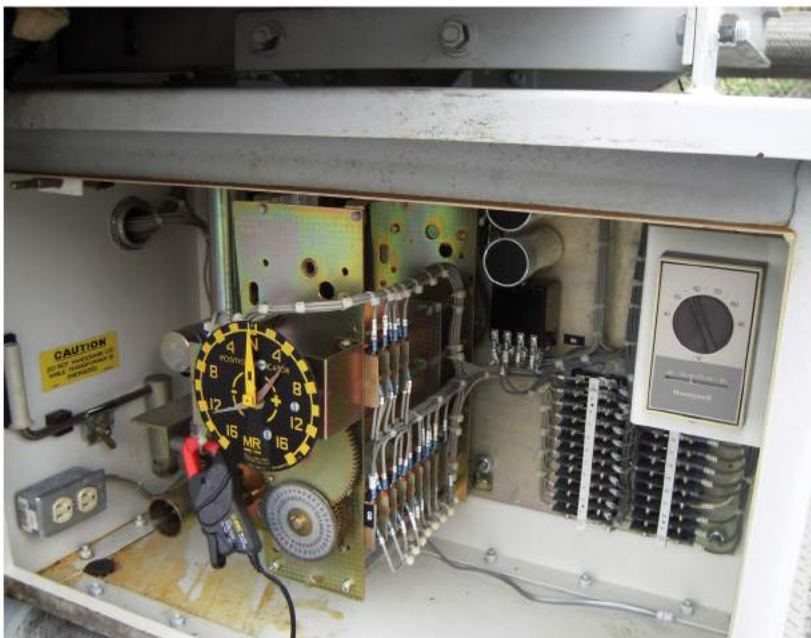

VOLTAGE TRANSDUCER ZVS-300V



Input voltage (-300V to +300V)
Analog output (-10V to +10V)

Used to record transient signals

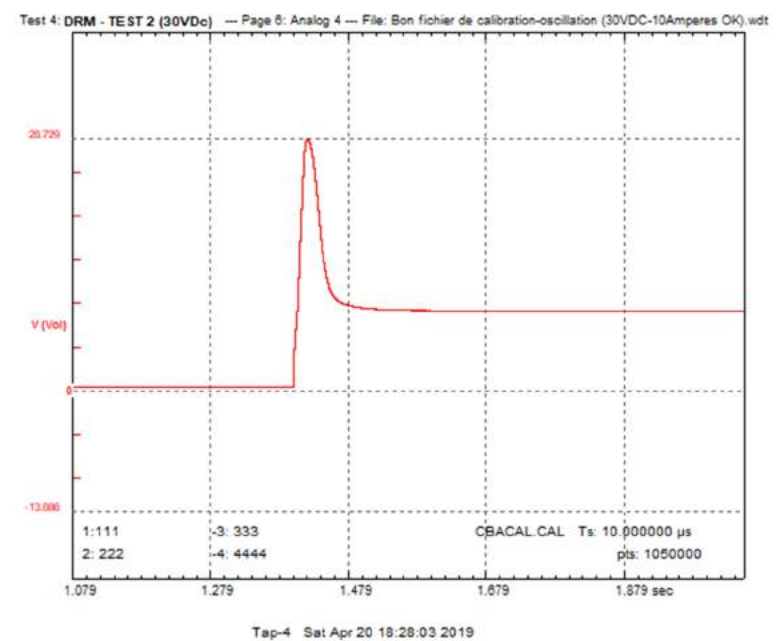

CABLES



ACCELEROMETER CABLE

Reference: C-BNC-03
Includes 10-32 to BNC connectors



COAXIAL EXTENSION CABLE

Reference: C-BNC-BNC
Male-to-male with female adapter
Lengths: 25 feet (7.62m) and 50 feet (15.24m)



CABLE REEL

Reference: BNC-REEL-4X50
Reel with four 50 feet BNC extensions



GROUND CABLE

Reference: GND-35
Grounding cable
Length: 35 feet (10.668m)

CASES & BAGS



REFERENCE: Z-VAL-7

Rigid transport case with wheels for TAP-4 cables and accessories, it may also be used to protect the OTM-X. Dimensions: 22"x17"x10" (56x43.2x25.4cm)



REFERENCE: Z-VAL-3

Rigid transport case with wheels for TAP-4 cables and accessories. Dimensions: 35"x14"x36" (88.9x35.6x25.4cm)



REFERENCE: Z-VAL-3 and Z-VAL-7

Sturdy, waterproof and easily carried, it protects your products from impacts and the elements.



REFERENCE: Z-BAG

Bag for carrying cables and accessories for the TAP-4

PROCESSING SOFTWARE OPENZEN-TAP

ON Site quick analysis

OFF Site deep analysis
Excel reports

Envelopes

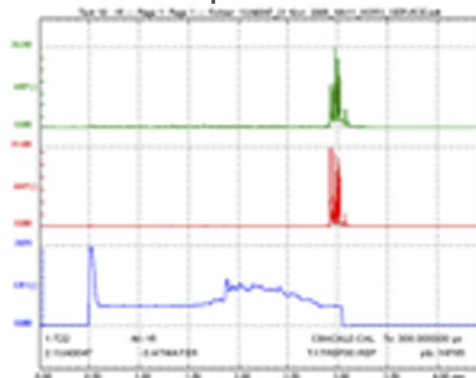

Contacts Wear

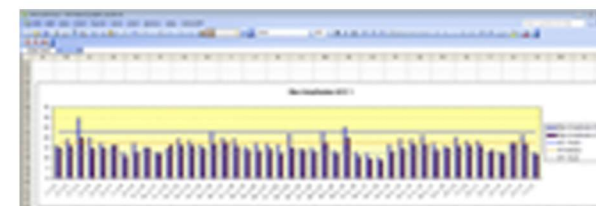

Raw data

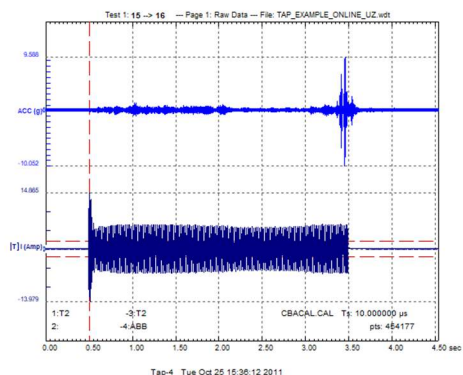

Envelopes

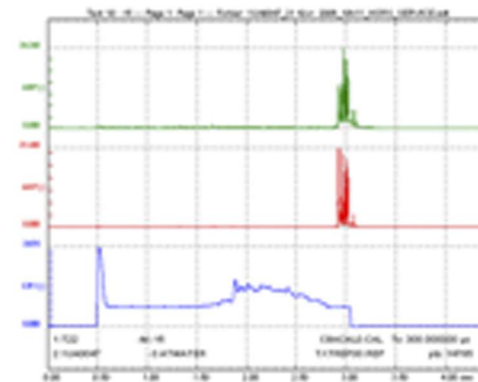

Excel reports



Comparison with Zensol database OLTC reference signatures

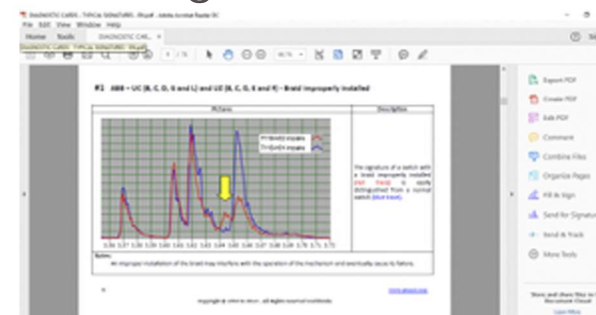

There are 2 tools to help analyze data: converting raw data into HQ envelopes and export to Zensol format

A diagnosis can be made in 15 minutes for an online test, and 1 hour for an off-line test.

TESTING SERVICES ANALYSIS SERVICES

OUR EXPERIENCE AT YOUR SERVICE!

Our diagnostic team has performed a multitude of tests on more than thousands of OLTCs around the world!





HOURS

Monday to Friday
8:30am to 5pm



E-MAIL

info.support@zensol.com



ADDRESS

Zensol Automation Inc.
2281 Guénette street
Saint-Laurent QC H4R 2E9, Canada



PHONE

Sales: +1 (514) 333-3488	ext 1
Technical support: +1 (514) 333-3488	ext 2
Accounting: +1 (514) 333-3488	ext 3